















Lo scorrevole più intuitivo di sempre



Scorrevoli

-  Sistemi di apertura intuitivi, come quelli di una finestra
-  Ricambio d'aria mentre lo scorrevole sembra chiuso
-  Sistemi ammortizzanti di chiusura di serie



-  Tenuta al vento **B3**
-  Isolamento acustico fino a **42 db**
-  Trasmittanza nodo anta/telaio **ARES 0.92 W/(m²K) con spugna 0.96 W/(m²K) standard**
-  Canalina **Warm Edge o Super Spacer**
-  Tenuta all'acqua **9A**
-  Guarnizioni n. **2 o 3 in EPDM (in base al sistema)**
-  Profondità telaio **82 mm (ARES)**
-  Tenuta all'aria **4**
-  Lato inferiore **Telaio su 4 lati**





Scorrevoli

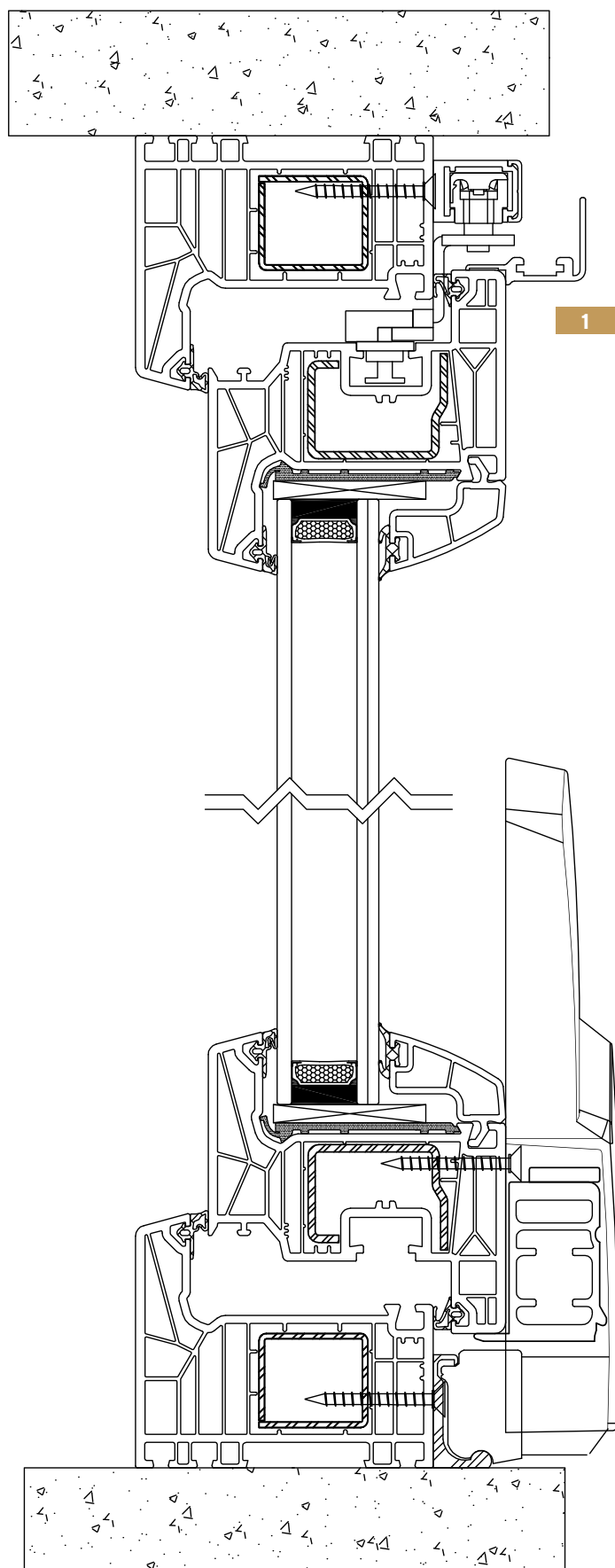

1

1

1 Guida e meccanismo



Esempi di apertura:

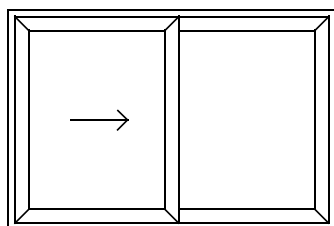

Apertura a 2 ante,
1 che scorre

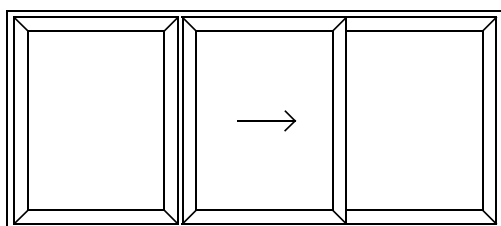

Apertura a 3 ante,
1 centrale che scorre

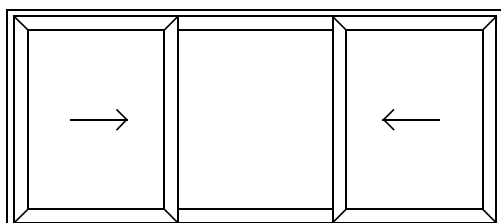

Apertura a 3 ante,
2 laterali che
scorrono

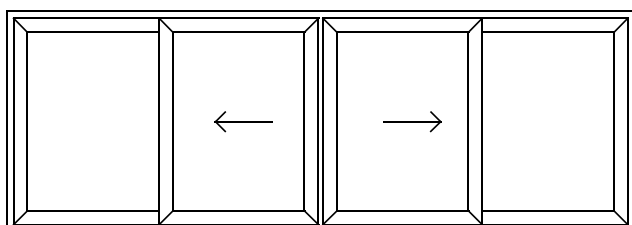

Apertura a 4 ante,
2 centrali che
scorrono



Tabella tecnica riassuntiva

Caratteristiche anta	SE MELISSA LISCIA (ARRONDATA A RICHIESTA) SE ATENA/ARES LISCIA
Guarnizioni	SEGUE SISTEMA MELISSA/ATENA/ARES
Posizione delle guarnizioni	SEGUE SISTEMA MELISSA/ATENA/ARES
Possibile spessore del vetro	SEGUE SISTEMA MELISSA/ATENA/ARES
Tipologia di fermavetro	LISCIO (DESIGN A RICHIESTA)
Camere del telaio - Camere dell'anta	SEGUE SISTEMA MELISSA/ATENA/ARES
Profondità di base del telaio	SEGUE SISTEMA MELISSA/ATENA
Sezioni del telaio	SEGUE SISTEMA MELISSA/ATENA
Ferramenta montata	MAICO TRICOAT-EVO
Tipi di apertura standard e relative opzioni di apertura	SCORREVOLE PIÙ MICROVENTILAZIONE
Chiusura anta semifissa	ANTA SECONDARIA FISSA O APRIBILE (A RICHIESTA)
Vetrocamera standard	4/18 ARGON/33.1 BE x F 33.1/15 ARGON/33.1 BE x PF
Canalina	Warm Edge GRIGIO O NERO (SEGUE COLORE PROFILO)
Maniglia Standard	MODELLO ATLANTA SECUSTICK LUNGA IN ALLUMINIO BIANCA, BRONZO, ARGENTO (SEGUE COLORE PROFILO)
Coperture standard	COPERTURA CARRELLO BIANCA, CROMO SATINATA (SEGUE COLORE PROFILI)
Soglia in alluminio	TELAIO SU 4 LATI
Tipologie e disponibilità colori	TUTTI
Consegna Smart	SI (SOLO SU ELLE)
Prestazioni nodo Uf	SEGUE SISTEMA MELISSA/ATENA/ARES